

Chapter 18.06
COMMERCIAL DISTRICTS

18.06.000 Chapter Contents

Sections:

- [18.06.020](#) Purposes.
- [18.06.040](#) Permitted, conditional, and prohibited uses.
- [18.06.060](#) Commercial districts' use standards.
- [18.06.080](#) Commercial districts' development standards (General).
- [18.06.100](#) Commercial districts' development standards (Specific).
- [18.06.120](#) Additional regulations.

18.06.060 Commercial districts' use standards

D. Banks.

1. High Density Corridor-3 (HDC-3) Requirements. Banks which offer only drive-through service (i.e., which serve customers exclusively in or on their vehicles) are not permitted.

2. Urban Waterfront (UW) and Downtown Business (DB) District Requirements. Drive-through banks may be permitted with a conditional use permit if the proposed project meets the Street Edge Development Standards of the Pedestrian Streets Overlay District, Chapter [18.16 OMC](#) if outside of the Downtown Design District or the Street Fronts standards of Chapter 18.120.220 for projects in the Downtown Design District. ~~The proposed project may be exempted from the Pedestrian-Oriented Street Wall Requirement under the "Pedestrian Streets Overlay District Requirements" if it is found that:~~
 - ~~a.—The proposed design meets the intent of the Pedestrian Streets Overlay District, "Pedestrian Streets Overlay District Requirements"; and~~

 - ~~b.—The building site presents unusual conditions which require an alternative design to accomplish the intent of the Pedestrian Streets Overlay District, "Pedestrian Streets Overlay District Requirements."~~

BB. Wholesale Sales. The following Conditional Use Permit restrictions apply to wholesale uses:

1. Urban Waterfront (UW) District Requirements. Wholesale sales are a permitted use in those portions of the UW District [for](#) which ~~the use is are~~ not [within the Pedestrian Streets Overlay District \(see Chapter 18.16\)](#). ~~directly~~

adjacent to a Type A or B Street (~~Street types are as shown in Section 18.120.140, OMC~~). In those portions of the UW District which are ~~within the Pedestrian Streets Overlay District~~ directly adjacent to a Type A or B street, wholesale sales may be allowed as a conditional use if the proposed project meets the ~~Street Edge Development~~ applicable Street Fronts Standards of the ~~Pedestrian Streets Overlay District~~ Downtown Design Criteria, Chapter 18.120. The proposed project may be exempted from the ~~Pedestrian-Oriented Street Wall Requirement~~ Street Fronts standards in Chapter 18.120 if:

- a. The proposed design meets the intent of the Chapter; and
- b. The building site presents unusual conditions which require an alternative design to accomplish the intent.

2. Commercial Services - High Density (CS-H) District Requirements. Permitted uses include those which offer specialized products at wholesale to other uses permitted in this district, including, but not limited to, office machine sales and repair services, and office supply sales.

HH. Urban Waterfront Housing. Up to a maximum of 1 FAR (floor area ratio) can be made up of allowed uses other than residential. (~~Refer to Pedestrian Street Overlay District 18.16.060(B) for amount and location of commercial uses in a predominantly residential project on "A" streets.~~)

18.06.080 Commercial districts' development standards (General)

A. General Standards. The standards contained in Table 6.02 (Commercial Districts' Development Standards) relating to lot area, building setbacks, development coverage, building coverage, and building height apply to commercial districts as indicated. They may be a minimum requirement (e.g. minimum lot size), or a maximum allowance (e.g., maximum height). Many of the standards in Table 6.02 are summaries of more detailed information found in Section 18.06.100, Specific Development Standards.

18.06.080 TABLES: Commercial Districts' Development Standards

**TABLE 6.02
COMMERCIAL DISTRICTS' DEVELOPMENT STANDARDS**

STANDARD	NR	PO/RM	GC	HDC-1	HDC-2	HDC-3	HDC-4 and HDC-4 Capital Mall	ADDITIONAL REGULATIONS
MINIMUM LOT SIZE	7,200 Sq. Ft.	No minimum, except 1,600 = cottage 3,000 = zero lot 1,600 sq. ft. minimum 2,400 sq. ft. average = townhouse 6,000 sq. ft. = duplex 7,200 sq. ft. = multifamily 4,000 = other	No minimum, except 1,600 sq. ft. minimum 2,400 sq. ft. average = townhouse	No minimum, except 1,600 = cottage 3,000 = zero lot 1,600 sq. ft. minimum 2,400 sq. ft. average = townhouse 6,000 sq. ft. = duplex 7,200 sq. ft. = multifamily 4,000 = other	No minimum, except 1,600 = cottage 3,000 = zero lot 1,600 sq. ft. minimum 2,400 sq. ft. average = townhouse 6,000 sq. ft. = duplex 7,200 sq. ft. = multifamily 4,000 = other	No minimum, except 1,600 sq. ft. minimum 2,400 sq. ft. average = townhouse	No minimum, except 1,600 sq. ft. minimum 2,400 sq. ft. average = townhouse	See also 18.06.100(D) for regulations on existing undersized lots of record.
FRONT YARD SETBACK	See Chapter 18.110 , Basic Commercial Design Criteria	10' maximum, if located in a High Density Corridor; 10' minimum otherwise.	5' minimum for residential otherwise none.	0-10' See 18.130	0-10' See 18.130	0-10' See 18.130	0-10' See 18.130	1. 50' minimum from property line for agriculture buildings (or structures) which house animals other than pets.

**TABLE 6.02
COMMERCIAL DISTRICTS' DEVELOPMENT STANDARDS**

STANDARD	NR	PO/RM	GC	HDC-1	HDC-2	HDC-3	HDC-4 and HDC-4 Capital Mall	ADDITIONAL REGULATIONS
								2. Must comply with clear sight triangle requirements, Section 18.40.060(C) . 3. Must comply with site design standards, Chapter 18.100 .
REAR YARD SETBACK	15' minimum.	10' minimum; Except: 1. Next to an R 4, R 4-8, or R 6-12 district = 15' minimum + 5' for each bldg. floor above 2 stories. 2. Next to MR 7-13, MR 10-18, RM-18, RM-24 or RMH	10' minimum; Except: 1. Next to single-family use or an R 4, R 4-8, or R 6-12 district = 15' minimum + 5' for each bldg. floor above 2 stories. 2. Next to MR 7-13, MR 10-18, RM-18, RM-24 or RMH district	10' minimum; Except: 1. Next to an R4, R4-8, or R6-12 district = 15' minimum + 5' for each bldg. floor above 2 stories; 10 ft. where an alley separates HDC-1 from the above residential district.	10' minimum; Except: 1. Next to an R4, R4-8, or R6-12 district = 15' minimum + 5' for each bldg. floor above 2 stories; 10 ft. where an alley separates HDC-2 from the above residential district.	10' minimum; Except: 1. Next to single-family use or an R4, R4-8, or R6-12 district = 15' minimum + 5' for each bldg. floor above 2 stories. 2. Next to MR7-13, MR10-18, RM-18, RM-24 or RMH	10' minimum; Except: 1. Next to single-family use or an RLI, R4, R4-8, or R6-12 district - 15' minimum + 5' for each bldg. floor above 2 stories. 2. Next to MR7-13, MR10-18, RM-18, RM-24 or RMH	1. 50' minimum from property line for agriculture buildings (or structures) which house animals other than pets. 2. Must comply with site design standards, Chapter 18.100 .

**TABLE 6.02
COMMERCIAL DISTRICTS' DEVELOPMENT STANDARDS**

STANDARD	NR	PO/RM	GC	HDC-1	HDC-2	HDC-3	HDC-4 and HDC-4 Capital Mall	ADDITIONAL REGULATIONS
		district = 10' minimum + 5' for each bldg. floor above 2 stories.	(refer to 1 above if adjacent use is single-family) = 10' minimum + 5' for each bldg. floor above 2 stories.	2. Next to MR7-13, MR 10-18, RM-18, RM-24 or RMH district = 10' minimum + 5' for each bldg. floor above 2 stories.	2. Next to MR7-13, MR 10-18, RM-18, RM-24, or RMH district = 10' minimum + 5' for each bldg. floor above 2 stories.	district (refer to 1 above if adjacent use is single-family) = 10' minimum + 5' for each bldg. floor above 2 stories.	district (refer to 1 above if adjacent use is single-family) = 10' minimum + 5' for each bldg. floor above 2 stories.	
SIDE YARD SETBACK	15' minimum.	No minimum on interior, 10' minimum on flanking street; Except: 1. Next to R 4, R 4-8, or R 6-12 district = 15' minimum + 5' for each building floor above 2 stories. 2. Next to MR 7-13,	No Minimum; Except: 1. Next to R 4, R 4-8, or R 6-12 district = 15' minimum + 5' for each building floor above 2 stories. 2. Next to MR 7-13, MR 10-18, RM-18, RM-24 or RMH district = 10' minimum + 5' for each	No minimum on interior, 10' minimum on flanking street; Except: 1. Next to R4, R4-8, or R6-12 district = 15' minimum + 5' for each building floor above 2 stories. 2. Next to MR7-13, MR10-18, RM-18, RM-	No minimum on interior, 10' minimum on flanking street; Except: 1. Next to R4, R4-8, or R6-12 district = 15' minimum + 5' for each building floor above 2 stories. 2. Next to MR7-13, MR10-18, RM-18, RM-	No Minimum; Except: 1. Next to R4, R4-8, or R6-12 district = 15' minimum + 5' for each building floor above 2 stories. 2. Next to MR7-13, MR10-18, RM-18, RM-24 or RMH district = 10' minimum + 5'	No Minimum; Except: 1. Next to RLI, R4, R4-8, or R6-12 district = 15' minimum + 5' for each building floor above 2 stories. 2. Next to MR7-13, MR10-18, RM-18, RM-24 or RMH district = 10'	1. 50' minimum from property line for agriculture buildings (or structures) which house animals other than pets. 2. Must comply with clear sight triangle requirements, Section 18.40.060(C) . 3. Residential side_yards can

**TABLE 6.02
COMMERCIAL DISTRICTS' DEVELOPMENT STANDARDS**

STANDARD	NR	PO/RM	GC	HDC-1	HDC-2	HDC-3	HDC-4 and HDC-4 Capital Mall	ADDITIONAL REGULATIONS
		MR 10-18, RM-18, RM-24 or RMH district = 10' minimum + 5' for each bldg. floor above 2 stories. 3. Residential excluding mixed use structures: 5' except 6' on one side of zero lot.	bldg. floor above 2 stories. 3. Residential excluding mixed use structures: 5' except 6' on one side of zero lot.	24 or RMH district = 10' minimum + 5' for each bldg. floor above 2 stories. 3. Residential excluding mixed use structures: 5' except 6' on one side of zero lot.	24 or RMH district = 10' minimum + 5' for each building floor above 2 stories. 3. Residential excluding mixed use structures: 5' except 6' on one side of zero lot.	for each bldg. floor above 2 stories. 3. Residential excluding mixed use structures; 5' except 6' on one side of zero lot.	minimum + 5' for each bldg. floor above 2 stories. 3. Residential excluding mixed use structures; 5' except 6' on one size of zero lot.	be reduced consistent with 18.04.080(H)(5). 4. Must comply with site design standards, Chapter 18.100 .
MAXIMUM BUILDING HEIGHT	Up to 35'; whichever is less.	Up to 35', if any portion of the building is within 100' of R 4, R 4-8, or R 6-12 district; Up to 60' otherwise.	Up to 35', if any portion of the building is within 100' of R 4, R 4-8, or R 6-12 district; Up to 60' otherwise; or up to 70', if at	The portion of a building within 100' of land zoned for maximum density of less than 14 units per acre is limited to 35'. The portion of	The portion of a building within 100' of land zoned for maximum density of less than 14 units per acre is limited to 35'. The portion of	The portion of a building within 100' of land zoned for maximum density of less than 14 units per acre is limited to 35'. The portion of	The portion of a building within 100' of land zoned for maximum density of less than 14 units per acre is limited to 35'. The portion of	1. Not to exceed height limit set by State Capitol Group Height District, 18.10.060, for properties near the State Capitol Campus.

**TABLE 6.02
COMMERCIAL DISTRICTS' DEVELOPMENT STANDARDS**

STANDARD	NR	PO/RM	GC	HDC-1	HDC-2	HDC-3	HDC-4 and HDC-4 Capital Mall	ADDITIONAL REGULATIONS
			<p>least 50% of the required parking is under the building; or up to 75', if at least one story is residential.</p>	<p>a building within 50' of land zoned for a maximum density of 14 units per acre or more is limited to the lesser of 60' or the height allowed in the abutting district. Up to 60' otherwise. Provided that one additional story may be built for residential development only.</p>	<p>a building within 50' of land zoned for a maximum density of 14 units per acre or more is limited to the lesser of 60' or the height allowed in the abutting district. Up to 60' otherwise. Provided that one additional story may be built for residential development only.</p>	<p>a building within 50' of land zoned for a maximum density of 14 units per acre or more is limited to the lesser of 60' or the height allowed in the abutting district. Up to 60' otherwise; or up to 70', if at least 50% of the required parking is under the building; or up to 75', if at least one story is residential.</p>	<p>a building within 50' of land zoned for a maximum density of 14 units per acre or more is limited to the lesser of 60' or the height allowed in the abutting district. Up to 60' otherwise; or up to 70', if at least 50% of the required parking is under the building; or up to 75', if at least one story is residential. See 18.130.060</p>	<p>2. Must comply with site design standards, Chapter 18.100. 3. HDC-1 and HDC-2 additional story must comply with OMC 18.06.100.A.6. 4. In the Downtown Design District, see 18.120.220 and 18.120.440 for upper story step back requirements.</p>

**TABLE 6.02
COMMERCIAL DISTRICTS' DEVELOPMENT STANDARDS**

STANDARD	NR	PO/RM	GC	HDC-1	HDC-2	HDC-3	HDC-4 and HDC-4 Capital Mall	ADDITIONAL REGULATIONS
							<p>Significant Building Entry tower exemption (allows an additional 30' for a tower element at Capital Mall). Up to 75' for HDC-4 zoned properties where the proposed project provides for the development of replacement dwelling units in a development agreement and the project site is all or part of</p>	

**TABLE 6.02
COMMERCIAL DISTRICTS' DEVELOPMENT STANDARDS**

STANDARD	NR	PO/RM	GC	HDC-1	HDC-2	HDC-3	HDC-4 and HDC-4 Capital Mall	ADDITIONAL REGULATIONS
							an area of 40 acres or more that was in contiguous common ownership in 2009.	
MAXIMUM BUILDING COVERAGE	45%	70%, except 55% for residential only structures	70%; or 85% if at least 50% of the required parking is under the building.	70% for all structures	70% for all structures	70% for all structures, 85% if at least 50% of the required parking is under the building.	70% for all structures. 85% of the site if at least 50% of the required parking is under the building. On redeveloped sites, 85% if at least 50% of new required parking is under the building or in a structured parking form.	For projects in the GC and HDC-4 zones west of Yauger Way, limitations of building size per 18.06.100(C) and 18.130.020 apply.

**TABLE 6.02
COMMERCIAL DISTRICTS' DEVELOPMENT STANDARDS**

STANDARD	NR	PO/RM	GC	HDC-1	HDC-2	HDC-3	HDC-4 and HDC-4 Capital Mall	ADDITIONAL REGULATIONS
							85% for HDC-4 zoned properties where the proposed project provides for the development of replacement dwelling units in a development agreement and the project site is all or part of an area of 40 acres or more that was in contiguous common ownership in 2009.	
MAXIMUM IMPERVIOUS	50%	70%	85%	85% for all structures	85% for all structures	85% for all structures	85% for all structures	See OMC 18.06.100(D) .

**TABLE 6.02
COMMERCIAL DISTRICTS' DEVELOPMENT STANDARDS**

STANDARD	NR	PO/RM	GC	HDC-1	HDC-2	HDC-3	HDC-4 and HDC-4 Capital Mall	ADDITIONAL REGULATIONS
SURFACE COVERAGE								
MAXIMUM HARD SURFACE	60%	85%, except 75% for residential structures						
ADDITIONAL DISTRICT-WIDE DEVELOPMENT STANDARDS	Maximum building size (gross sq. ft.): 3,000 for single use; 6,000 for mixed use.	Building floors above 3 stories which abut a street or residential district must be stepped back a minimum of 8 feet (see 18.06.100(B) and Figure 6-3). <u>In the Downtown Design District, see Chapter 18.120 for</u>	Building floors above 3 stories which abut a street or residential district must be stepped back a minimum of 8 feet (see 18.06.100(B)). <u>In the Downtown Design District, see Chapter 18.120 for upper story stepbacks.</u>	Building floors above 3 stories which abut a street or residential district must be stepped back a minimum of 8 feet (see 18.06.100(B)).	Building floors above 3 stories which abut a street or residential district must be stepped back a minimum of 8 feet (see 18.06.100(B)).	Building Floors above 3 stories which abut a street or residential district must be stepped back a minimum of 8 feet (see 18.06.100(B)).	Building floors above 3 stories which abut a street or residential district must be stepped back a minimum of 8 feet (see 18.06.100(B)).	For properties in the vicinity of the Downtown or Kaiser Road and Harrison Ave NE, also see Pedestrian Streets Overlay District, Chapter 18.16 . For retail uses over 25,000 square feet in gross floor area, see Section 18.06.100(G) Large Scale Retail Uses. EXCEPTION: Section

**TABLE 6.02
COMMERCIAL DISTRICTS' DEVELOPMENT STANDARDS**

STANDARD	NR	PO/RM	GC	HDC-1	HDC-2	HDC-3	HDC-4 and HDC-4 Capital Mall	ADDITIONAL REGULATIONS
		<u>upper story stepbacks.</u>						<u>18.06.100(G)</u> shall not apply to motor vehicle sales. <u>In the Downtown Design District, see Chapter 18.120.</u>

LEGEND

NR = Neighborhood Retail
GC = General Commercial

PO/RM = Professional
Office/Residential
Multifamily

HDC-1=High Density
Corridor-1
HDC-2=High Density
Corridor-2
HDC-3=High Density
Corridor-3
HDC-4=High Density
Corridor-4

**TABLE 6.02
COMMERCIAL DEVELOPMENT STANDARDS**

STANDARD	MS	UW	UW-H	DB	CS-H	AS	ADDITIONAL REGULATIONS
MINIMUM LOT AREA	7,200 Sq. Ft.	No minimum.	No minimum.	No minimum.	7,200 Sq. Ft. if bldg. height is 35' or less. 12,500 Sq. Ft. if bldg. height is over 35'.	No minimum.	
FRONT YARD SETBACK	10' maximum.	No minimum; however, see Chapter 18.100 for design guidelines for pedestrian access and view corridors. In the Downtown Design District: 12' from the curb on Type A and B Streets, 10' from curb for Type C Streets.	No minimum. In the Downtown Design District: 12' from the curb on Type A and B Streets, 10' from curb for Type C Streets.	No minimum. In the Downtown Design District: 12' from the curb on Type A and B Streets, 10' from curb for Type C Streets.	No minimum.	30' minimum for buildings; 15' for other structures except signs	1. 50' minimum from property line for agriculture buildings (or structures) which house animals other than pets. 2. Must comply with clear sight triangle requirements, Section 18.40.060(C) . 3. See Design Guidelines, Chapter 18.100 .
REAR YARD SETBACK	15' minimum; If next to a residential	No minimum; however, see Chapter 18.100 for	No minimum.	No minimum.	5' minimum if building has 1 or 2 stories.	15' minimum.	50' minimum from property line for

**TABLE 6.02
COMMERCIAL DEVELOPMENT STANDARDS**

STANDARD	MS	UW	UW-H	DB	CS-H	AS	ADDITIONAL REGULATIONS
	zone, 15' minimum plus 5' for every story over 3 stories.	design guidelines for pedestrian access and view corridors.			10' minimum if building has 3 or more stories.		agriculture buildings (or structures) which house animals other than pets.
SIDE YARD SETBACK	10' minimum; 15' minimum plus 5' for every story over 3 stories if next to a residential zone.	No minimum; however, see Chapter 18.100 for design guidelines for pedestrian access and view corridors.	No minimum.	No minimum.	5' minimum if building has 1 or 2 stories. 10' minimum if building has 3 or more stories; AND the sum of the 2 side yards shall be no less than 1/2 the building height.	5' minimum 30' minimum for buildings and 15' minimum for other structures from flanking streets.	1. 50' minimum from property line for agriculture buildings (or structures) which house animals other than pets. 2. Must comply with clear sight triangle requirements, Section 18.40.060(C) . 3. See Design Guidelines, Chapter 18.100 .
MAXIMUM BUILDING HEIGHT	75'; except hospitals, which may	See 18.06.100(A)(2) and Figure 6-2, Urban Waterfront	Refer to Figure 6-2 and 6-2B for specific	75'; PROVIDED, however, that two additional	75' Exception: Up to 100' may be allowed with conditional	40' accessory building	Not to exceed height limit set by State Capitol Group Height

**TABLE 6.02
COMMERCIAL DEVELOPMENT STANDARDS**

STANDARD	MS	UW	UW-H	DB	CS-H	AS	ADDITIONAL REGULATIONS
	exceed that height.	District Height Limits Exceptions: 1) In the portion of the area Downtown with a height limit of 65', two additional residential stories may be built. See 18.06.100(A)(2)(b). 2) In the portion of the area on West Bay Drive with a height limit of 42' to 65', the taller height limit is conditioned upon the provision of certain waterfront amenities. See 18.06.100(A)(2)(c).	height and building configurations required on specific blocks. In the Downtown Design District, see view protection measures in 18.06.100 and Chapter 18.120.	stories may be built, if they are residential. There are also restrictions around Sylvester Park. For details, see 18.06.100(C)(6) (C)(6) Height, Downtown Business District. In the Downtown Design District, see view protection measures in 18.06.100 and Chapter 18.120.	approval by the City Council, upon recommendation of the Hearing Examiner. For details, see 18.06.100(C)(5), Height, Commercial Services-High Density. In the Downtown Design District, see view protection measures in 18.06.100 and Chapter 18.120.	limited to 20'.	District, 18.10.060, for properties near the State Capitol Campus.
MAXIMUM BUILDING COVERAGE	50%	60% for properties between the shoreline and the nearest upland street.	100%	No requirement.	No requirement.	85%	

**TABLE 6.02
COMMERCIAL DEVELOPMENT STANDARDS**

STANDARD	MS	UW	UW-H	DB	CS-H	AS	ADDITIONAL REGULATIONS
		100% for properties not between the shoreline and the nearest upland street.					
MAXIMUM IMPERVIOUS SURFACE COVERAGE	60%	100% development coverage.	100%	100%	100%	85%	
MAXIMUM HARD SURFACE	65%						
ADDITIONAL DISTRICT-WIDE DEVELOPMENT STANDARDS	Building floors above 3 stories which abut a street or residential district must be stepped back a minimum of 8 feet (see 18.06.100(F)). Residential uses (Section 5 of Table	Street ends abutting the water shall be preserved to provide views of and public access to the water, pursuant to Section 12.16.050(D) OMC. See also Chapter 18.100 for Downtown design guidelines for	Street ends abutting the water shall be preserved to provide views of and public access to the water, pursuant to OMC Section 12.16.050(D) .		Residential uses must comply with High Rise Multi-family (RM-H) development standards.	6' of sight-screening buffer shall be provided along north, east, and west district boundaries. See Olympia Park Replat covenants for access,	For properties in the vicinity of the Downtown, also see Pedestrian Streets Overlay District, Chapter 18.16 and the Downtown Design Guidelines in 18.120 . For retail uses over 25,000

**TABLE 6.02
COMMERCIAL DEVELOPMENT STANDARDS**

STANDARD	MS	UW	UW-H	DB	CS-H	AS	ADDITIONAL REGULATIONS
	6.01) may not be constructed within 600 feet of Lilly Road except in upper stories of mixed use building; all other development standards are the same as for commercial uses.	Pedestrian Access and View Corridors and Waterfront Public Access; Chapter 18.100 for Port Peninsula design guidelines for Pedestrian Connections and View Corridors; Section 18.06.100(A)(2)(c) for West Bay Drive building height and view blockage limits; and Chapter 18.100 for West Bay Drive view corridors.				and other standards applicable to replat lots.	square feet in gross floor area, see Section 18.06.100 (GC) Large Scale Retail Uses. EXCEPTION: Section 18.06.100 (GC) shall not apply to motor vehicle sales.

LEGEND

MS = Medical Services CS-H = Commercial Services - High Density UW = Urban Waterfront
 DB = Downtown Business UW-H = Urban Waterfront-Housing
 AS=Auto Services

18.06.100 Commercial districts' development standards--Specific

A. Height.

1. Roof structures for the housing of elevators, stairways, tanks, ventilating fans and similar equipment required to operate and maintain the building, fire or parapet walls, skylights, towers, flagpoles, chimneys, smoke stacks, wireless masts, T.V. antennas, steeples and similar structures may be erected above the height limits prescribed in this Title, provided that no roof structure, feature or any other device above the prescribed height limit shall be allowed or used for the purpose of providing additional floor space. This height exception does not apply to the additional story provision for residential development described in OMC 18.06.100.A.6. Provided, further, that no roof structure or architectural feature shall be erected more than eighteen (18) feet above the height limit of the district, whether such structure is attached to it or free-standing.

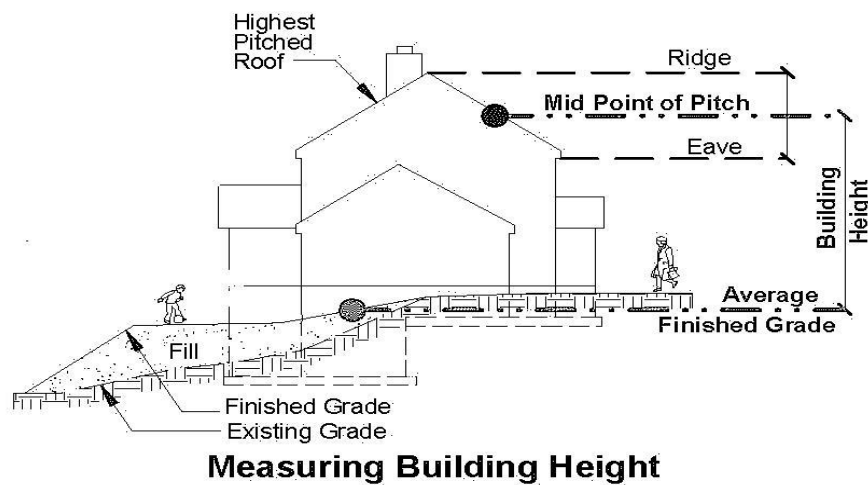

FIGURE 6-1A

2. Urban Waterfront (UW) District.
 - a. Allowed building heights in the Urban Waterfront (UW) District are specified in Figure 6-2. [THIS MAP MAY NEED TO BE AMENDED TO ALIGN WITH CHANGES TO 18.06.100\(A\)\(2\).](#)
 - b. Bonus for residential development.
 - i. In the area labeled sixty-five (65) feet on Figure 6-2, up to two additional stories may be built [\(except as limited in subsection d below\)](#), if the project is located in the downtown, and if the added stories are stepped back from the street wall at least eight (8) feet, and if an

equivalent floor area (equal to the amount from the added stories) is provided for residences, as follows:

- (a) In the same building--i.e., it is a residential or a mixed use building; or
- (b) With commercial and residential uses in separate buildings on the same site; or
- (c) With commercial and residential uses on separate sites within the Urban Waterfront (UW) district.

ii. Occupancy. Housing provided under this bonus provision as part of a mixed use project must receive an occupancy permit at the same time as, or in advance of, issuance of an occupancy permit for non-residential portions of the project.

iii. Conversion. Housing provided under this bonus provision shall not be converted to commercial use.

iv. Source of housing units. Housing provided under this bonus provision may be:

- (a) New construction,
- (b) Adaptive reuse of a formerly non-residential structure, or
- (c) Rehabilitation of existing housing.

c. West Bay Drive building height and view blockage limits.

i. In order to retain public and private view access to Budd Inlet from hillside sites above West Bay Drive, the maximum building height in the West Bay Drive portion of the Urban Waterfront (UW) District labeled " 42'-65' " on Figure 6-2 shall be up to a maximum of 42 feet, except as provided in subsections (iii) and (iv) below.

ii. In order to retain public view access of Budd Inlet from street level in the West Bay Drive portion of the Urban Waterfront (UW) District labeled " 42'-65' " on Figure 6-2, view blockage shall be limited as follows:

- (a) Views of the water will be defined as area without obstruction by buildings or major structures measured between 45 and 90 degrees to West Bay Drive, as illustrated in Figure 6-2A.

(b) Said view blockage shall be limited to 45 percent of the views of the water from West Bay Drive by buildings or major structures located between West Bay Drive and the mean high water line.

(c) Exceptions are provided in subsections (iii) and (iv) below.

iii. Development shall be subject to the alternate standards for building height and view blockage, if alternate waterfront view access is provided through public amenities as follows:

Amenity Provided	Limits on Horizontal View Blockage and Height
Waterfront Trail	70% up to 42 ft., OR 45% up to 65 ft.
Expanded Waterfront Trail Corridor Facility (or small waterfront park area).	50% up to 42 ft., OR 45% up to 50 ft.
Both	70% up to 65 ft.

Any development over 42 feet shall be required to include a minimum of 20% of the usable building area for residential purposes.

iv. Criteria for approval of alternate waterfront view access.

(a) Waterfront Trail.

(1) Trail right-of-way consistent with City trail standards shall be dedicated to the City.

(2) The trail shall be designed consistent with City standards and requirements, or as otherwise approved by the Olympia Parks, Arts and Recreation Department. Because the trail passes by different land uses, it may take a different character in different locations, for reasons of safety, privacy, or environmental protection.

(3) The developer shall design, build, and dedicate the facility to the City.

(4) An analysis of recreation needs shall be provided by the Olympia Parks, Arts and Recreation Department. An analysis of environmental impacts, hazardous waste risks, and engineering issues sufficient to determine the design and location for the trail facility shall be approved by the Olympia Parks, Arts and Recreation Department but provided by the developer. All analysis shall be complete prior to approval.

(b) Expanded Waterfront Trail Corridor Facility or Small Waterfront Park.

(1) The developer shall build and dedicate the facility and its site to the City.

(2) The expanded waterfront trail corridor facility or small park area shall be designed consistent with City and other applicable government standards and requirements, or as otherwise approved by the Olympia Parks, Arts and Recreation Department. The expanded waterfront trail corridor facility or small park may vary in size from City park standards and could include additional right-of-way for the expanded trail, landscaping, habitat enhancement, benches, lighting, parking, restrooms, garbage receptacles, telephones, interpretive signs and other park facilities.

(3) An analysis of environmental impacts, hazardous waste risks, trail improvements, and engineering issues sufficient to design the expanded waterfront trail corridor facility or small park area shall be approved by Olympia Parks, Arts and Recreation Department but provided by the developer. All analysis shall be complete prior to approval.

(4) The expanded waterfront trail corridor facility or small park shall have a publicly accessible connection to West Bay Drive, designed, constructed, and dedicated for public use by the developer.

v. The view blockage rules shall be applied on a project-wide basis and not for each lot or parcel in a project, thus allowing projects providing more views on some lots to have more view blockage on other lots as long as the overall project meets the view blockage requirements.

d. Landmark Views: In order to protect designated landmark views from public observation points, the height bonus allowed in subsection b, above, is limited as follows:

i. Block 14 Height Bonus: A view analysis of the proposed development shall be submitted that demonstrates the view of the Capitol Drum and Dome will remain visible from the East Bay Lookout after the development occurs. This may prohibit use of the height bonus, or restrict which portions of the block are eligible to use the bonus. Block 14 is bounded by Olympia Avenue, Adams Street, Thurston Avenue, and Jefferson Street.



- ii. Block 122: Height bonus is limited to one additional story, up to a maximum height of 75 feet. Block 122 is bounded by Olympia Ave, Jefferson Street, and Marine Drive.



- iii. Block 123: The bonus height provision is not applicable in this location. Block 123 is bounded by Corky Avenue and Market Street to south and industrial uses to the north.

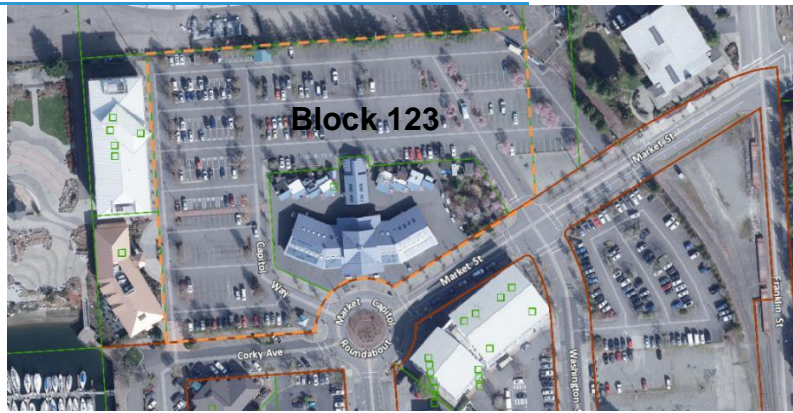
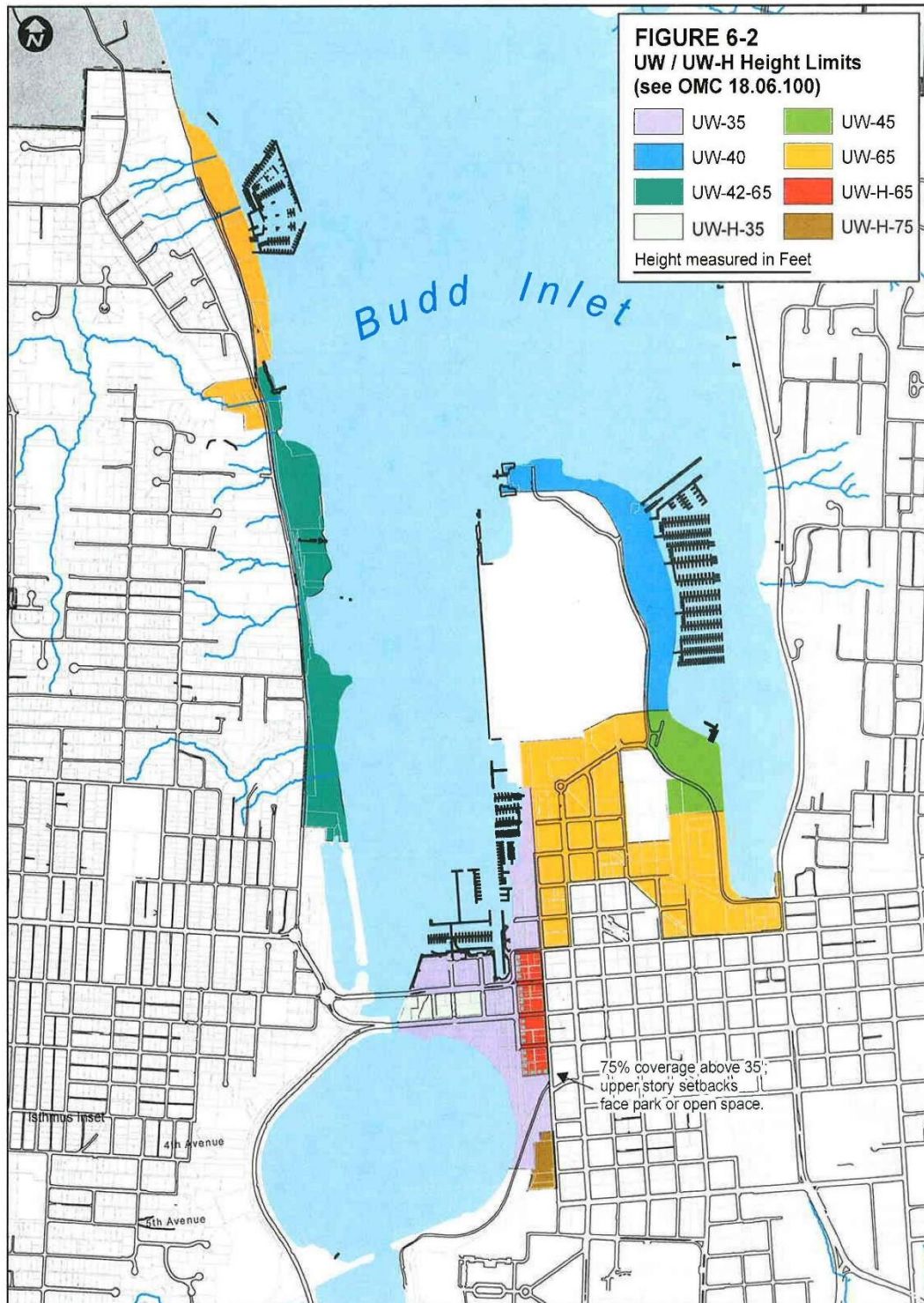

Figure 6-2 Urban Waterfront and Urban Waterfront Height Limits



[*See 18.06.100\(A\)\(2\) for height limitations that apply to Blocks 14, 122, and 123 in order to protect landmark views from specific observation points.](#)

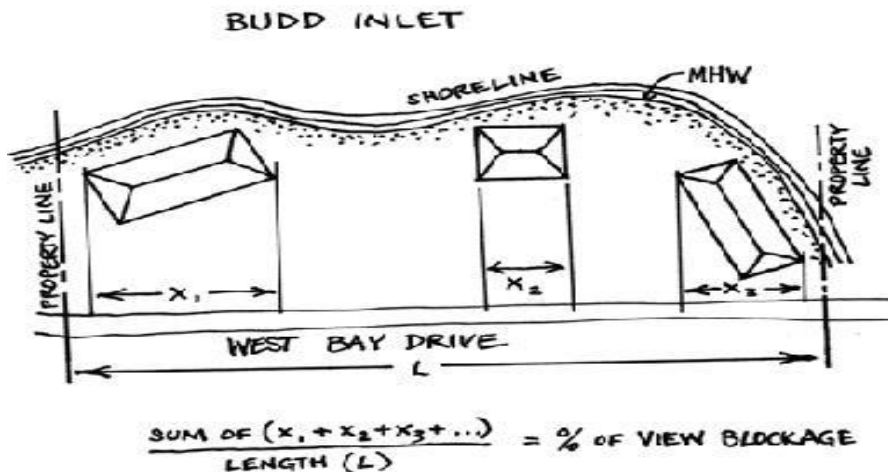

FIGURE 6-2A

Calculating View Blockage in a portion of the Urban Waterfront District along West Bay Drive.

3. Commercial Services-High Density. The maximum building height allowed is one hundred (100) feet. Provided, however, that no building or structure may exceed seventy-five (75) feet in height without conditional review and approval by the Hearing Examiner. Approval of structures exceeding seventy-five (75) feet in height shall meet the following criteria:

- a. The building design shall be compatible with or enhance the physical characteristics of the site, the appearance of buildings adjacent to the site and the character of the district.
- b. The site plan shall facilitate efficient and convenient circulation, shall include landscaping that creates a pleasing appearance from both within and off the site and shall be an asset to the community at large.
- c. Enhancement of public view access or direct public access to usable open space areas shall offset any potential upland view loss which may occur as a result of the proposal.

4. Downtown Business District.

- a. Building height allowed outright in the DB zone is seventy-five (75) feet.
- b. Bonus for residential development.
- c. Enhancement of public view access or direct public access to usable open space areas shall offset any potential upland view loss which may occur as a result of the proposal.

i. Buildings may exceed the height allowed outright (75 feet) by up to two (2) stories, if the added stories are stepped back from the street wall at least eight (8) feet, and if floor area equal to the amount from the added stories is provided for residences:

(a) In the same building--i.e., it is a residential or a mixed use building; or

(b) With commercial and residential uses in separate buildings on the same site; or

(c) With commercial and residential uses on separate sites within the Downtown Business (DB) zone.

ii. Occupancy. Housing provided under this bonus provision as part of a mixed use project must receive an occupancy permit at the same time as, or in advance of, issuance of an occupancy permit for non-residential portions of the project.

iii. Conversion. Housing provided under this bonus provision shall not be converted to commercial use.

iv. Source of housing units. Housing provided under this bonus provision may be:

(a) New construction,

(b) Adaptive reuse of a formerly non-residential structure, or

(c) Rehabilitation of existing housing.

5. Urban Waterfront - Housing.

a. Allowed building heights in the Urban Waterfront-Housing District are specified in Figure 6-2.

b. Required step backs and placement of step backs over 35 feet on specific blocks are specified in Figure 6-2.

6. High Density Corridor (HDC - 1 and HDC - 2).

a. Building height allowed outright in the HDC-1 and HDC-2 zones as outlined in OMC [18.06.080](#), Table 6.02.

b. Additional story for residential development.

- i. Additional story can only be allowed for those development that do not provide a mechanical "penthouse" room as allowed under the provisions of OMC [18.06.100.A](#). However, the additional story can be occupied with both residential development and mechanical equipment.
- ii. Buildings may exceed the height allowed outright in OMC [18.06.080](#), Table 6.02, by one (1) story. The additional story cannot exceed fourteen (14) feet above the maximum allowable height requirement as specified in OMC [18.06.080](#), Table 6.02.
- iii. The additional story must be stepped back at least eight (8) feet from any abutting street or any abutting residential zoning district. See OMC 18.06.100.B.2.
- iv. Housing provided under this additional story as part of a mixed use project must receive an occupancy permit at the same time as, or in advance of, issuance of an occupancy permit for non-residential portions of the project.
- v. Housing provided under this additional story provision shall not be converted to commercial use. Except that the residential units may conduct business activities under the provision for home occupations. See OMC [18.04.060.I](#).
- vi. Housing provided under this bonus provision may be:
 - (a) New construction;
 - (b) Adaptive reuse of a formerly non-residential structure, or
 - (c) Rehabilitation of existing housing.
- vii. This additional story is not available and will not be approved within 100 feet of a designated historic district.

B. Upper Story StepBacks.

1. High Density Corridor-1 (HDC-1), Community Retail (CMR), High Density Corridor-2 (HDC-2), General Commercial (GC), High Density Corridor-4 (HDC-4), Medical Services (MS), and Professional Office/Residential Multifamily (PO/RM) District Requirements:

Building floors above three (3) stories which abut a street or residential district must be stepped back a minimum of eight (8) feet (see Figure 6-3).

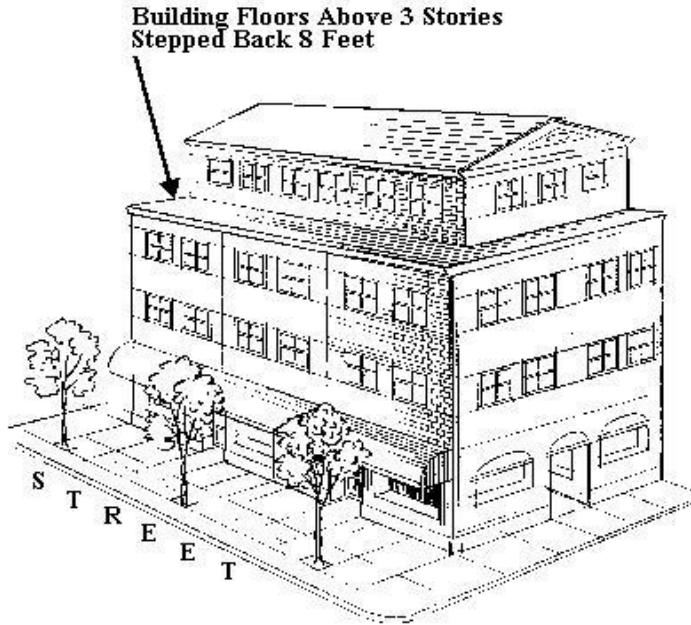

FIGURE 6-3

2. Additional Story Provision for HDC-1 and HDC-2. Projects within the HDC-1 and HDC-2 zoning districts which use the additional story provisions for residential development as outlined in OMC 18.06.100.A.6, must step the additional story back by a minimum of eight (8) feet. The step back is required for the additional story which abuts a street or residential district.

C. Large Scale Retail Uses. Retail uses over twenty-five thousand (25,000) square feet in gross floor area under common ownership or use shall meet the design requirements of this section. For purposes of this section, a retail use under common ownership or use shall mean a single establishment which shares checkstands, management, a controlling ownership interest, or storage areas, e.g., a plant nursery or a grocery store associated with a general merchandise store, such as a home improvement store.

In General Commercial and HDC-4 zones west of Yauger Way, single story or single use commercial retail space shall not occupy more than 60,000 square feet of enclosed building space on the ground floor, unless a development agreement is approved. These buildings shall be designed and oriented to provide for pedestrian and bicycle circulation throughout the site and to adjacent buildings and properties. A building larger than 60,000 square feet can be allowed when it is not directly adjacent to a street designated as an "A" street in the Pedestrian Street Overlay and if a development agreement is approved that at a minimum addresses:

- 1) Building orientation, massing, and use of high quality materials
- 2) Parking is located to the rear or side of the building, or is separated from the street by additional retail buildings

3) Pedestrian, bicycle, and vehicular circulation on site and connections to adjacent properties

4) Community assets, such as the multi-use trail identified in the Kaiser Harrison Opportunity Area Plan

1. Customer entrances. Customer entrances shall be provided on each facade that faces an abutting street, customer parking, or a public park or plaza, up to a maximum requirement of three customer entrances per business occupancy. If there are two or more facades facing abutting streets, at least two such facades must provide a customer entrance. An entrance on a corner of the building may count as serving two facades. Such entrances shall provide both ingress and egress, and shall be double doors, not just single units. See Figure 6-4.

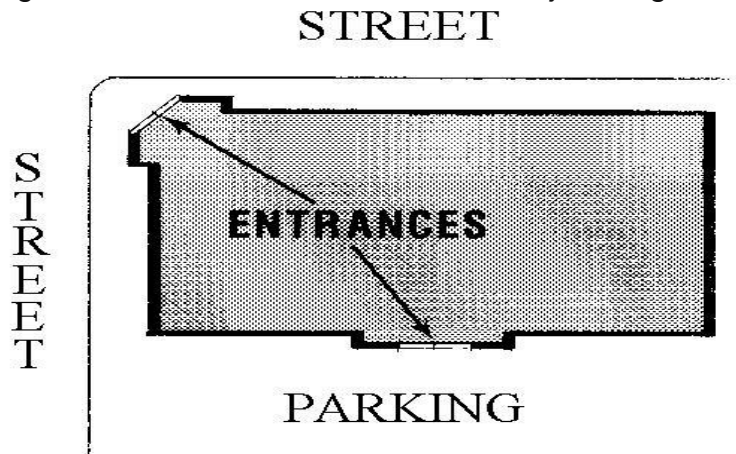

Customer Entrances must be provided on facades facing abutting streets and parking. Example shows corner entrance serving two street facades, plus entrance serving parking.

FIGURE 6-4

2. Rain protection. Awnings, canopies, marquees, arcades, building overhangs or similar forms of pedestrian weather protection, at least four and one half (4 1/2) feet wide, shall be provided over a pedestrian walkway along at least eighty (80) percent of any facade with a customer entrance. See Figure 6-5. Such weather protection shall be placed no less than eight (8) feet above the walkway. If placed more than eight (8) feet above the walkway, such weather protection shall be at least an additional six (6) inches in width for each additional foot of height, or portion thereof. See Figure 6-6.

Development in the HDC-4 Capital Mall Area shall use design standards established for this area instead of the above rain protection regulation. See 18.130.050 HDC 4-Capital Mall.

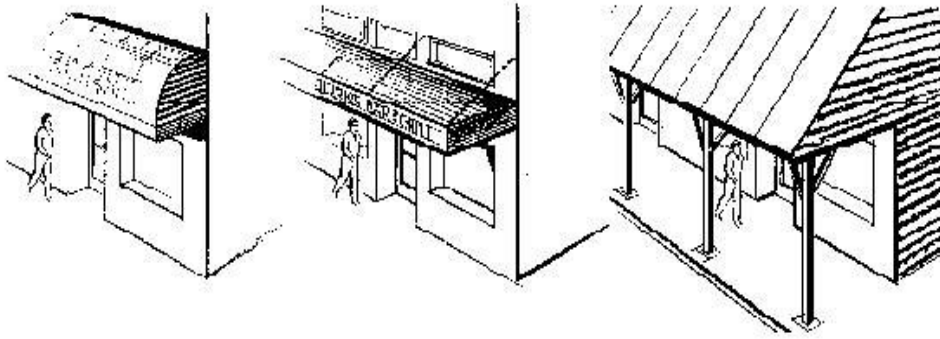

**Rain Protection (L to R): Awning, Marquee, Arcade
FIGURE 6-5**

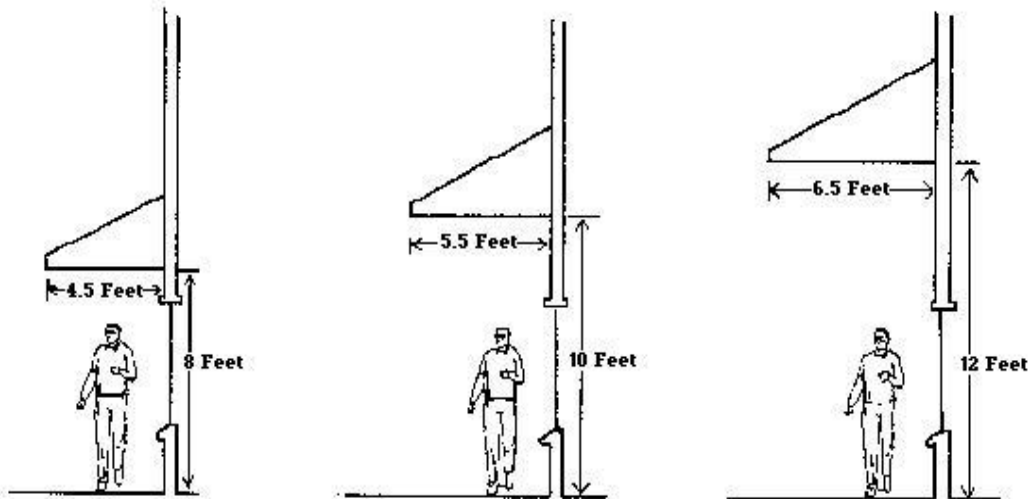

**Width of Rain Protection is determined by height above walkway.
FIGURE 6-6**

3. Wall articulation. Facades greater than fifty (50) feet in length shall incorporate wall plane projections or recesses having a depth of at least three percent (3%) of the length of the facade and extending in the aggregate at least twenty percent (20%) of the length of the facade. No uninterrupted length of any such facade shall exceed fifty (50) horizontal feet. **EXCEPTION:** This requirement shall not apply to walls which:

- a. have no customer entrance; and
- b. are only visible from service areas, and not from nearby residences or from the customer parking lot or an abutting street.

Development in the HDC-4 Capital Mall Area shall use design standards established for this area instead of the above wall articulation regulation. See 18.130.050 HDC 4-Capital Mall.

4. Frontage limit. The frontage per business occupancy shall be limited to one hundred (100) feet along any facade facing an abutting street, unless sixty percent (60%) or more of the facade between two (2) and eight (8) feet above the sidewalk is in transparent glazing; i.e., transparent windows, display windows, or transparent store doors (staff note: this would allow a major tenant to have lots of its own display windows, or to lease peripheral space to lots of small tenants, or to look like it was doing so, or to build added stories to get added floor area). See Figures 6-7 through 6-12. EXCEPTION: This requirement shall not apply to that portion of a facade where the average grade level of the sidewalk of the abutting street is 4 feet or more above or below the adjacent floor level of the building. See Figure 6-13. Development in the HDC-4 Capital Mall Area shall use design standards established for this area instead of the above frontage limit. See 18.130.050 HDC 4-Capital Mall.



**Example of building with 100' frontage, hence exempt from transparent glazing requirement.
FIGURE 6-7**

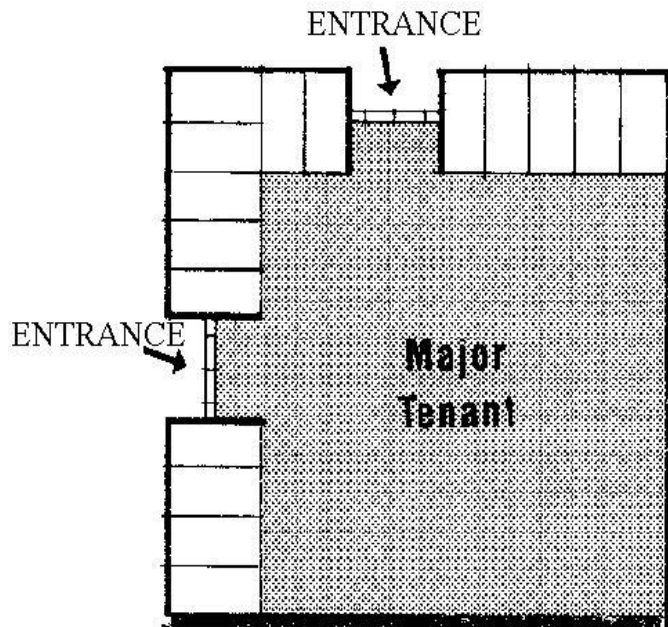

**Frontage limited by placing small shops on periphery of building, plan view.
FIGURE 6-8**



Small shops on periphery of building, elevation view.
FIGURE 6-9



150-foot frontage with 60% of facade between 2' and 8' in transparent glazing.
FIGURE 6-10



25,000 square foot 1-story building with 150 feet of frontage
FIGURE 6-11



50,000 square foot building on 2 stories with 150 feet of frontage
FIGURE 6-12

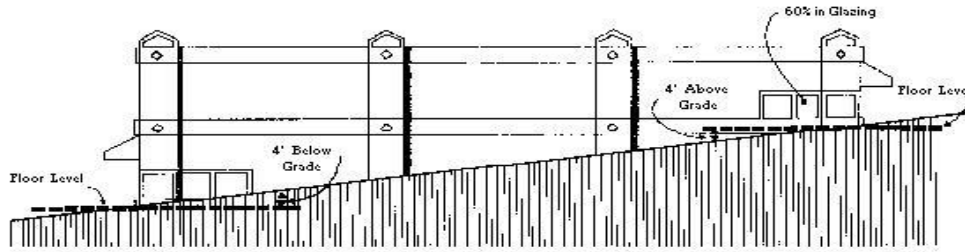

Transparency requirement does not apply to the portion of a facade with a floor level over 4' above or below grade.

FIGURE 6-13

5. Very Large Scale Retail Facilities. Retail uses under common ownership or use, which exceed size thresholds set forth in subsection (a) below for the zone in which the retail uses are proposed, shall meet the additional development and design requirements specified in subsections (a)(ii)-(iv). Those which exceed size thresholds set forth in subsection (b) below for the zone in which the retail uses are proposed shall be subject to the requirements for Conditional Use approval provided in subsection (b)(ii).

a. Added development and design requirements for Very Large Scale Retail Facilities

i. Thresholds for requirements

District	Size (gross floor area)
GC	60,000 sq. ft.
HDC-2	40,000 sq. ft.
HDC-3	50,000 sq. ft.
HDC-4, except Capital Mall Area	60,000 sq. ft.
UW	40,000 sq. ft.
UW-H	25,000 sq. ft.
DB	25,000 sq. ft.
UC	50,000 sq. ft.

ii. Adaptability for Reuse/Compartmentalization. The building design shall include specific elements that facilitate the structure's adaptation for multi-tenant reuse. Such elements may include but are not limited to compartmentalized construction, including plumbing, electrical service, heating, ventilation and air conditioning. The building design shall also allow for all of the following:

(1) Subdivision of the interior of structure into separate tenancies. The design for interior subdivision shall accommodate multiple potential tenancies, each no larger than fifty percent (50%) of the size threshold for the district defined in subsection (i) above. Example A: An applicant designs a 120,000 sq. ft. Very Large Scale Retail Use in the GC district to accommodate reuse by four potential tenancies of 30,000 sq. ft. each. Example B: An applicant designs the same building to accommodate two potential tenancies of 30,000 sq. ft., and four potential tenancies of 15,000 sq. ft.

(2) Facades that readily adapt to multiple entrances without compromising the structural integrity of the building, and adapt to entrances on at least two sides of the building; or, if the building is designed to have only one front facade, all potential tenancies shall be designed for access from the front facade.

(3) Parking lot designs that are shared by establishments or are linked by safe and functional pedestrian connections.

(4) Landscaping schemes that complement the multiple entrance design.

(5) Design and placement of loading docks/loading bays to accommodate multiple potential tenancies.

(6) Other elements of design which facilitate the multi-tenant reuse of the building and site.

iii. Parking Design.

(1) Parking lots with over one acre in paving shall be designed for on-site infiltration of the stormwater generated on site. This may be accommodated by underground infiltration vaults, porous paving, or other techniques permitted by the City of Olympia Stormwater Drainage Manual, and subject to the approval of the Department of Public Works.

(2) Bicycle parking shall meet all requirements of the City's bicycle parking regulations, in particular Sections [18.38.100](#) Vehicular and Bicycle Parking Standards, and 18.38.220 Design Standards - General.

iv. Site Design.

(1) The site design shall include a plan for pedestrian circulation with logical connections between buildings, between buildings and

adjacent streets, and from buildings to parking areas. (See also Sections [18.110.030](#), [18.120.110](#), and [18.150.030](#).)

(2) Pedestrian walkways within the development shall be differentiated from driving surfaces through a change in materials, and shall be designed to accommodate persons with disabilities, such as wheelchair users.

b. Conditional Use Approval

i. Thresholds for Conditional Use Approval

District	Size (gross floor area)
GC	125,000 sq. ft.
HDC-2	60,000 sq. ft.
HDC-3	75,000 sq. ft.
HDC-4, except Capital Mall Area	125,000 sq. ft.
UW	60,000 sq. ft.
UW-H	40,000 sq. ft.
DB	40,000 sq. ft.
UC	100,000 sq. ft.

ii. Conditions for Approval. The following requirements apply to all Very Large Scale Retail Facilities subject to conditional use approval.

(1) The Hearing Examiner shall determine that the proposed facilities meet the development and design requirements of subsection (a) above, and all other requirements of this Title.

(2) The Hearing Examiner shall determine that the proposed facilities will not be detrimental to the health, safety, or welfare of the general public, nor injurious to property, improvements or potential development in the vicinity, with respect to aspects including but not limited to the following:

(a) The nature of the proposed site, including its size and shape, and the proposed size, shape and arrangement of structures;

(b) The accessibility and traffic patterns for persons and vehicles, the type and volume of such traffic, and the adequacy of proposed off-street parking and loading;

(c) The safeguards afforded to prevent noxious or offensive emissions such as noise, glare, dust and odor; and

(d) The treatment given, as appropriate, to such aspects as landscaping, screening, open spaces, parking and loading areas, service areas, lighting and signs.

(e) The impact upon public facilities or public services.

6. Additional Regulations. Refer to the following Chapters for additional related regulations:

- a. Chapter [18.36](#), Landscaping and Screening
- b. Chapter [18.38](#), Parking and Loading
- c. Chapter [18.48](#), Conditional Uses
- d. Chapter [18.100](#), Design Review
- e. Chapter [18.110](#), Basic Commercial Design
- f. Chapter [18.120](#), ~~Commercial Design Criteria~~ Downtown [Design Criteria](#)
- g. Chapter [18.130](#), Commercial Design Criteria High Density Corridor (HDC)
- h. Chapter [18.150](#), Port Peninsula

D. Impervious Surface Coverage

On development sites incorporating 'vegetated roofs,' the impervious surface coverage limits of Neighborhood Retail, Professional Office/Residential Multifamily and Medical Service districts shall be increased one square foot for each square foot of vegetated roof area up to 5% of the total site area if adequate assurance is provided that the proposed vegetated roof will provide substantial stormwater management benefits for a period of at least 30 years.

18.06.120 Additional regulations

Refer to the following Chapters for additional related regulations.

Chapter 18.100- Design Guidelines
145

Chapter [18.36](#) Landscaping and Screening

Chapter [18.38](#) Parking and Loading

Chapter [18.40](#) Property Development and Protection Standards

Chapter [18.4243](#) Signs

Article III Overlay Districts